

KENWOOD

KDC-C66FM KDC-C56FM

CD AUTOCHANGER / CONTROLLER / FM MODULATOR
SYSTEM ▶ Page 2-29

INSTRUCTION MANUAL

CONTROLEUR POUR CHANGEUR AUTOMATIQUE DE CD /
SYSTEME A MODULATION DE FREQUENCE ▶ Page 31-57

MODE D'EMPLOI

SISTEMA DEL MODULADOR DE FM / CONTROLADOR / CAMBIADOR
AUTOMATICO DE DISCOS COMPACTOS ▶ Página 59-85

MANUAL DE INSTRUCCIONES

KENWOOD CORPORATION



Take the time to read through this instruction manual. Familiarity with installation and operation procedures will help you obtain the best performance from your new compact disc auto changer.

For your records

Record the serial number, found on the back of the unit, in the spaces designated on the warranty card, and in the space provided below. Refer to the model and serial numbers whenever you call upon your KENWOOD dealer for information or service on the product.

Model KDC-C66FM/C56FM Serial number

Contents

Before use

Warning	3
Safety precautions	4
Handling compact discs	6
Features	7
Loading compact discs	8

Disc changer control features

CD play with CD auto-changer.....	10
Track/Disc search	11
Direct track/disc search.....	12
Track repeat.....	13
Disc repeat.....	14
Track scan	15
Disc scan.....	16
Disc random play	17
Magazine random play.....	18

Installation

Changing the transmission frequency	19
Modulation level/Dynamic control	20
Installation procedure.....	21
Connections.....	22
Installation	23

Troubleshooting guide.....	27
-----------------------------------	-----------

Specifications	29
-----------------------------	-----------

Warning

▲CAUTION

Use of controls or adjustments or performance of procedures other than those specified herein may result in hazardous radiation exposure. In compliance with Federal Regulations, following are reproductions of labels on, or inside the product relating to laser product safety.

KENWOOD CORPORATION
2967-3, ISHIKAWA-CHO,
HACHIOJI-SHI
TOKYO, JAPAN

KENWOOD CORP. CERTIFIES THIS EQUIPMENT
CONFORMS TO DHHS REGULATIONS NO.21 CFR
1040. 10, CHAPTER I, SUBCHAPTER J.

Location : Rear Panel

FCC WARNING

This equipment may generate or use radio frequency energy. Changes or modifications to this equipment may cause harmful interference unless the modifications are expressly approved in the instruction manual. The user could lose the authority to operate this equipment if an unauthorized change or modification is made.

NOTE

This equipment has been tested and found to comply with the limits for a Class B digital device, pursuant to Part 15 of the FCC Rules. These limits are designed to provide reasonable protection against harmful interference in a residential installation. This equipment may cause harmful interference to radio communications, if it is not installed and used in accordance with the instructions. However, there is no guarantee that interference will not occur in a particular installation. If this equipment does cause harmful interference to radio or television reception, which can be determined by turning the equipment off and on, the user is encouraged to try to correct the interference by one or more of the following measures:

- Reorient or relocate the receiving antenna.
- Increase the separation between the equipment and receiver.
- Connect the equipment into an outlet on a circuit different from that to which the receiver is connected.
- Consult the dealer or an experienced radio/TV technician for help.

NOTE

This Class B digital apparatus meets all requirements of the Canadian interference-Causing Equipment Regulations.

Safety precautions

Before use

⚠ WARNING

Take the following precautions to prevent fire and avoid personal injury :

- When extending the ignition cable, battery cable, or ground cable, use 0.75mm² (AWG18) or larger automotive grade cable to avoid cable deterioration or damage to the covering.
- Check that no metal objects (coins, tools, etc.) are left inside the unit to avoid short circuits.
- If you smell or see smoke, turn the power off immediately and consult your Kenwood dealer.

⚠ CAUTION

Take the following precautions to keep the unit in proper working order.

- Be sure the unit is connected to a 12V DC power supply with a negative ground connection.
- Do not open the top or bottom cover.
- Do not install the unit in places it is exposed to direct sunlight, high heat or humidity, water may splash over it, or dust exists.
- If you need to replace the fuse, make sure the new fuse is of the same type and rating. Using a fuse of a different type of rating may damage your unit. The fuse rating is normally shown on the fuse and fuse box.
- If you need to replace the fuse, unplug the wiring harness before replacing the fuse to prevent short circuits.
- Do not set the remote control on hot places such as above the dashboard.

NOTE

- If you have difficulty in installing this unit in your vehicle, contact your Kenwood dealer.
- If it doesn't seem to be working properly, first press the Reset button. If the malfunction persists, consult your Kenwood dealer.

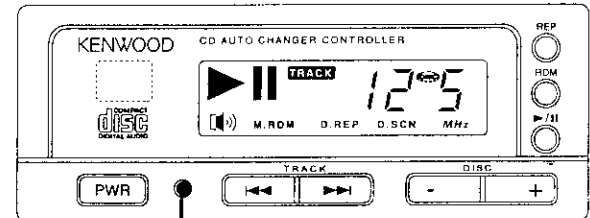

Reset button

- Some car stereos cause the sound of the tuner to make for a moment when an engine is activated.
- The reception of the tuner may be reduced a little if the KDC-C66FM, KDC-56FM is used.
- If the sound is lower than the tuner sound, raise up the volume level of the CD with using the receiver.

Cleaning the unit

- If the front panel is dirty, wipe it clean with a silicon cloth or soft dry cloth with the power off.

⚠ CAUTION

Do not use hard cloths or paint thinner, alcohol, or other volatile solvents. These may damage external surfaces or remove indicator characters.

Lens fogging

- In cold climates, there may be a period after you turn on your vehicle's heater when the lens that guides the laser beam used in your CD player fogs up. If this happens, you cannot play compact discs. Take out discs and the fogging will disappear. If it does not return to normal after several hours, contact your Kenwood dealer.

▲CAUTION

Do not set the remote on hot places such as above the dashboard.

Replacing the Lithium Battery

Use one lithium battery (CR2025). Remove the case following the instructions as illustrated. Insert the battery with the ⊕ and ⊖ poles aligned properly, following the illustration inside the case.

▲WARNING

Store unused lithium batteries out of the reach of children. Contact a doctor immediately if the battery is accidentally swallowed.

To open

- ① Keep on slide
- ② Pull out.

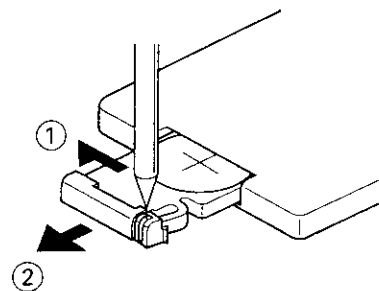

Handling compact discs

Before use

Stains, scratches, or warping can cause skipping, malfunction, or low sound quality. Take the following precautions to avoid damage to the compact discs.

Holding a disc

- Avoid touching the recorded side (the side without the titles on) when you hold a compact disc.

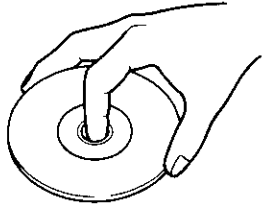

- Do not stick paper tape, etc. on either side of the disc.

Paper tape

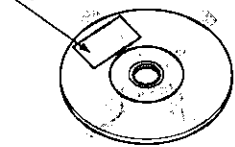

Storing your discs

- Do not store discs where they will be exposed to direct sunlight (such as on the seat and dashboard) or high heat.
- If you do not use your unit for an extended time, remove the discs from the unit and put them in their cases. Do not leave them lying around without cases, piled up, or leaning on a wall and so on.

Cleaning your discs

- If there are stains on a disc, wipe them off with a cleaning cloth or a soft cotton cloth, wiping from the center to the edge. Never use conventional record cleaners, anti static agent, paint thinner, benzene, or other chemicals.

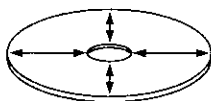

Check your new discs

- Some new discs have burrs on their outer edges or around the hole in the center. Discs with burrs may not fit properly on the player, causing skipping when they are played. Use a ballpoint pen or similar instrument to remove the burrs.

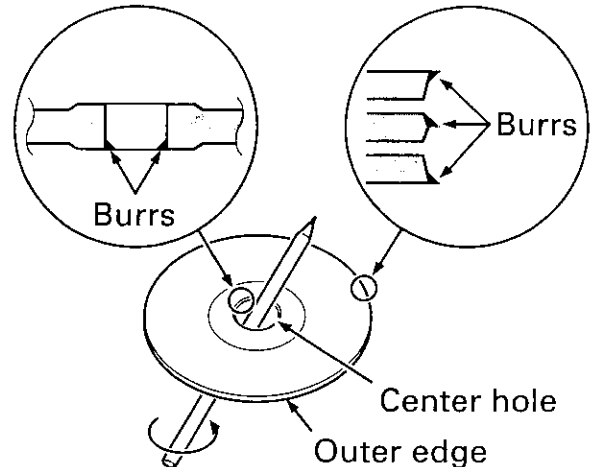

Disc accessories

- Stabilizers, protective seals, and other disc accessories on the market, which claim to offer improved sound quality or disc protection, may cause this unit to malfunction. They should not be used on discs played in this unit.

CAUTION

Never use 8 cm (3") compact discs

- If you attach an adapter to an 8 cm (3") compact disc and load it into this unit, the adapter may be detached from the disc, causing damage to the unit. Do not use 8 cm (3") compact discs.

Features

- **Frequency modulation system**
Even if your car audio(car stereo) is not equipped with an AUX input jack, you can use the radio's builtin FM tuner to listen to music played by the CD autochanger using FM broadcast frequencies.
One of the twelve transmission frequencies can be set to avoid interference with an (actual) FM broadcast station.
- **Disc changer control (Page 10)**
This unit has a Disc changer control function.
- **Track / Disc search (Page 11)**
You can search for the track / disc you want by specifying the track / disc number.
- **Direct track/disc search (Page 12)**
This feature allows you to enter the number of the track or disc you wish to hear by pressing the appropriate numeric keys.
- **Track repeat (Page 13)**
When this function is turned on, the track you are listening to is played repeatedly.
- **Disc repeat (Page 14)**
When this function is turned on, the disc you are listening to is played repeatedly.
- **Track scan (Page 15)**
When this function is turned on, the first part of each track on the disc you are listening to is played automatically to help you find the one you want.
- **Disc scan (Page 16)**
When this function is turned on, the first part of each disc in the Disc changer is played automatically to help you find the one you want from the magazine loaded in the Disc changer.
- **Disc random play (Page 17)**
When this function is turned on, the tracks on the disc you are listening to are played in random order.
- **Magazine random play (Page 18)**
When this function is turned on, the tracks on the discs in your Disc changer are played in random order.
- **Modulation level control (Page 20)**
The modulation level can be changed in the range between 1 to 4 according to the recording level of the disc you are listening to.
- **Dynamic control (Page 20)**
The unit has a prevention of distortion function to reduce sound distortion.

Loading compact discs

Before use

1

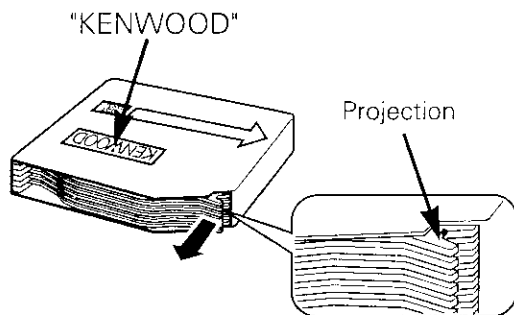

Make sure the disc magazine is the right way up with the Kenwood logo on the top. Pull the tray out by the projection.

2

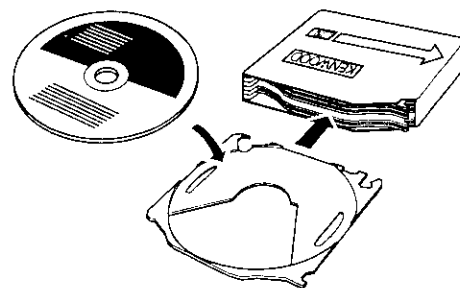

Place the disc on the tray with the label facing upwards. Insert the tray into the disc magazine until it locks. Check that the discs and trays are inserted properly. The discs are numbered from the bottom from 1 to 6.

CAUTION

- Take care to insert trays into the correct grooves in the disc magazine and to insert discs properly into the tray grooves. Otherwise malfunction may occur or the disc may be damaged.
- Insert all trays even when some of them do not carry discs. Otherwise malfunction or operation failure may occur.
- 8-cm discs cannot be used. If an 8-cm disc adapter is used, the disc cannot be ejected.

3

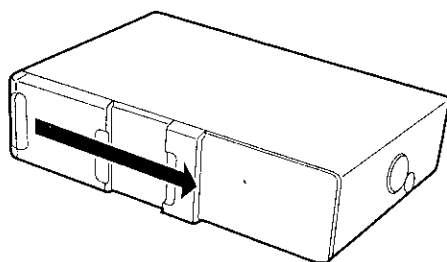

Open the CD changer door.

4

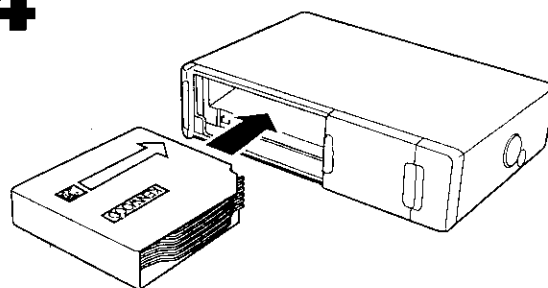

Insert the magazine into the CD changer until it clicks.

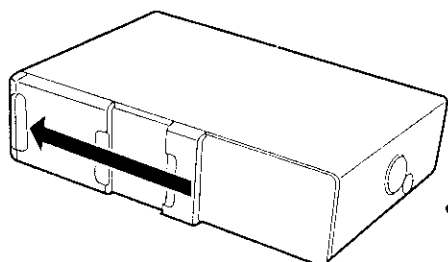
5

Close the CD changer door.

NOTE

Use the CD changer with its door closed to prevent the entry of dust into the changer.

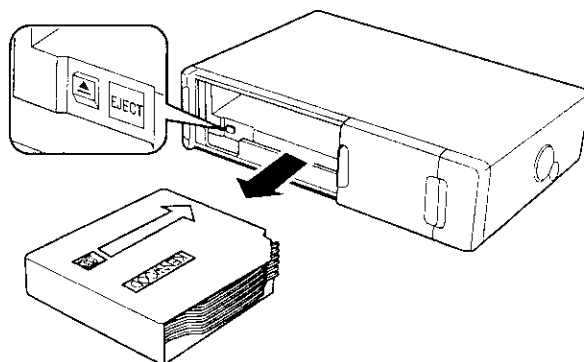
6 Magazine ejection

Open the CD changer door, and press the "EJECT" button.

NOTE

Be sure to open the door completely before pressing the EJECT button. If the door is not completely open, the magazine may hit the door and cause damage or malfunction.

CD play with CD auto-changer

Set the car radio FM station to 88.3 MHz. See Page 19 for more information on changing the transmission frequency.

Disc changer control features

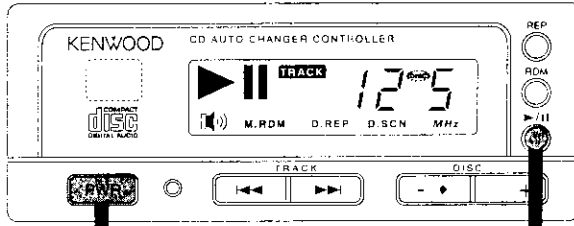

Power button

Play / Pause button

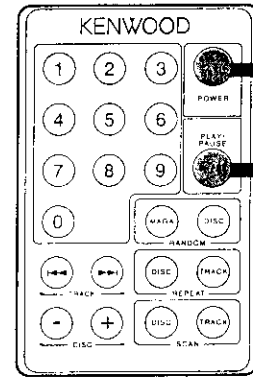

Power button

Play / Pause button

(Supplied with the KDC-C66FM)

To play compact discs

Press the Power button.

The power goes ON and the CD play start. When the unit receives any signal from the remote controller, the  mark lights up.

To listen to the radio

Press the Power button.

The RF modulator is turned OFF and the radio can be heard.

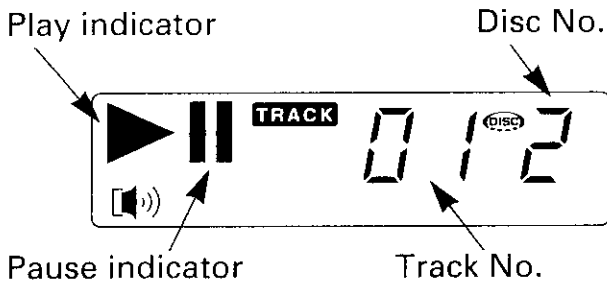

Pause

Press the Play/Pause button.

Disc play is temporarily paused. If you press the switch once more, the disc is replayed from the paused part.

When the player reaches the end of the last track on the disc you are playing, it will shift automatically to the first track on the next disc. When the player plays the last disc, it will return to the first disc. The play display blinks during disc replacement.

NOTE

- Be sure to turn down the volume whenever you listen to the radio or a cassette tape after stopping the disc play.
- During the disc play is being conducted, you are not able to receive ordinary Radio broadcasting because antenna output is switched into compact disc player's side.

Power off

Press the Power button.
The power goes OFF.

Track/Disc search

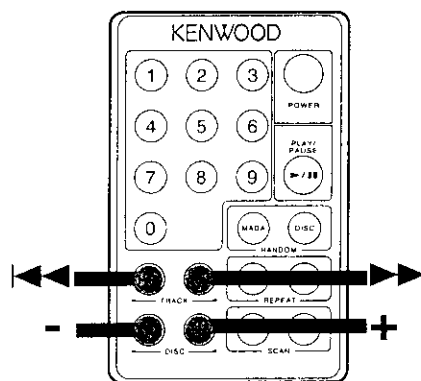
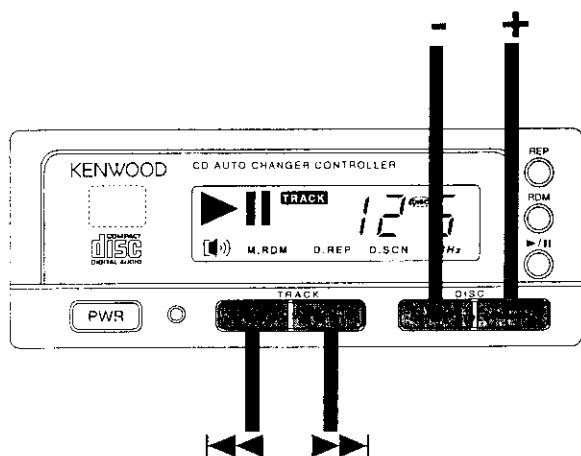

(Supplied with the KDC-C66FM)

Reverse track search

Briefly press the **◀◀** button.

When you press this button once, the player returns to the start of the track you are listening to. Each time you press the button, the track number on the display decreases. The player plays the track with the track number shown on the display.

When the **◀◀** button on the display unit is held down, the player fast-rewinds while playing the track.



NOTE

If you try reverse track search while playing track 1, the player will resume play at the start of track 1; it does not search for the last track.

NOTE

If you try forward track search while playing the last track on a disc, the Forward track search function does not work.

Reverse disc search

Press the **-** button.

Each time you press this button, the disc number on the display decreases. The player plays the disc with the disc number shown on the display.

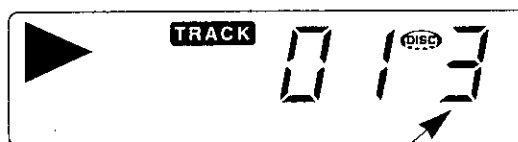

Disc No.

Forward track search

Briefly press the **▶▶** button.

Each time you press this button, the track number on the display increases. The player plays the track with the track number shown on the display.

When the **▶▶** button on the display unit is held down, the player fast-forwards while playing the track.

Forward disc search

Press the **+** button.

Each time you press this button, the disc number on the display increases. The player plays the disc with the disc number shown on the display.

Direct track/disc search

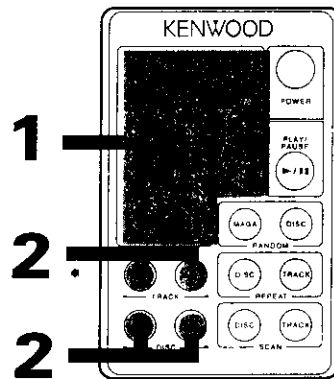

(Supplied with the KDC-C66FM)

1

Enter the number of track or disc you want to listen to. The input number blinks for 10 seconds and stays lit.



NOTE

- If a track number that does not exist on the disc you are listening to is displayed, carry out the operation in step 2, and the direct track search is made to the last track.

2

Direct track search

Press the ◀◀ or ▶▶ button while the number is blinking.

The player starts playing the track specified in step 1.

If three or more numbers are entered, the last two entered digits (shown on the display) are valid.

Direct disc search

Press the - or + button while the number is blinking.

The player starts playing the disc specified in step 1.

When two digits are displayed, the direct disc search is made to the disc number corresponding to the number on the right side.

To cancel

To cancel search in the middle, press the ▶/|| button.

The Direct track/disc search is cancelled and the normal display returns.

Also, if you do nothing for 10 seconds, the search will automatically cancel.

Track repeat

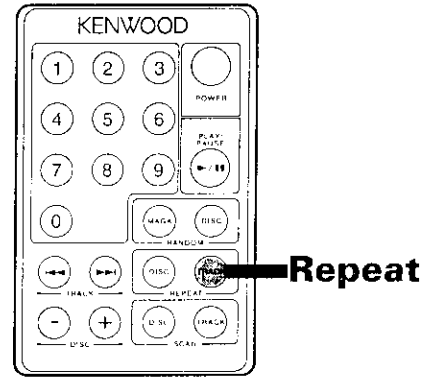
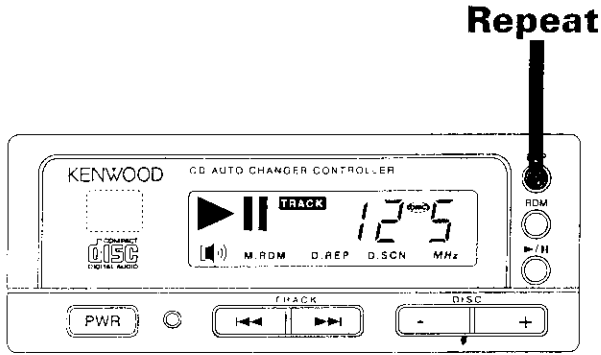

(Supplied with the KDC-C66FM).

To repeat track

Press the Repeat button.
The Repeat indicator will appear on the display and the Track repeat function will turn on.
The same track is played repeatedly.

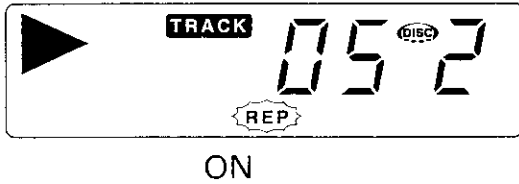

To cancel

Press the Repeat button.
The Repeat indicator disappears and the Track repeat function is cancelled.

NOTE

When disc play stops, Track repeat is cancelled.

Disc repeat

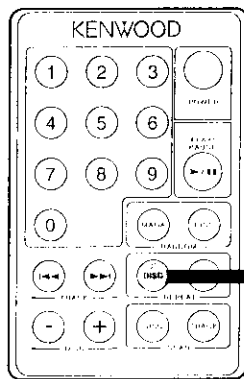

(Supplied with the KDC-C66FM)

To repeat disc

Press the Disc repeat button.
The Disc repeat indicator will appear on the display and the Disc repeat function will turn on.
The same disc is played repeatedly.



ON

To cancel

Press the Disc repeat button.
The Disc repeat indicator disappears and the Disc repeat function is cancelled.

NOTE

When disc play stops, Disc repeat is cancelled.

Track scan

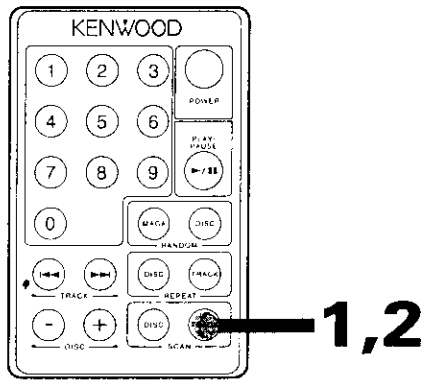

(Supplied with the KDC-C66FM)

1

Press the Track scan button.
The Track scan indicator will appear on the display and the player will play the first 10 seconds of each track in succession.



2

To select a track
Press the Track scan button.
The Track scan indicator disappears and the Track scan is cancelled.
Normal playback starts.

NOTE

- When disc play stops, Track scan is cancelled.
- When all tracks on the disc you are listening to are scanned, Track scan is cancelled.

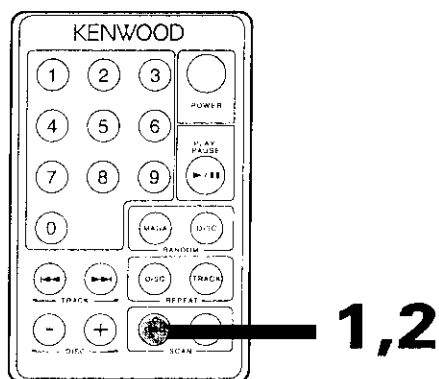

(Supplied with the KDC-C66FM)

1

Press the Disc scan button.
The Disc scan indicator will appear on the display and the player will play the first 10 seconds from each disc in succession.



2

To select a disc
Press the Disc scan button.
The Disc scan indicator disappears and the Disc scan is cancelled.
Normal playback starts.

NOTE

- When disc play stops, Disc scan is cancelled.
- When all discs in the magazine you are listening to are scanned, Disc scan is cancelled.

Disc random play

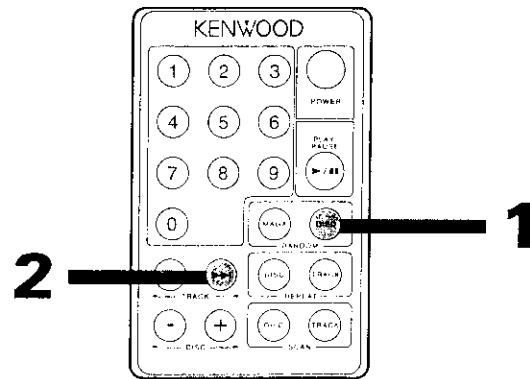
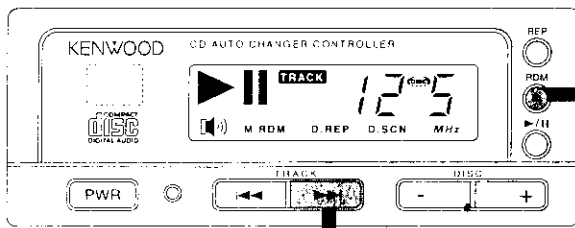

(Supplied with the KDC-C66FM)

1

Press the Disc random button.
The Random indicator will appear on the display and the player will randomly select another track from the disc you are playing. The track numbers on the display will change continuously during track selection. When a track is selected, playback will begin automatically.

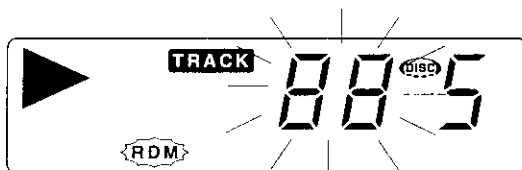

ON

NOTE

When all the tracks on a disc have been played, the player will randomly select the next disc.

2

To select another track
Press the ►► button.
The player will randomly choose another track.

To cancel

Press the Disc random button.
The Random indicator disappears and Random play is cancelled. Normal disc play starts.

NOTE

When the disc play stops, the Disc random play function is cancelled.

Magazine random play

Disc changer control features

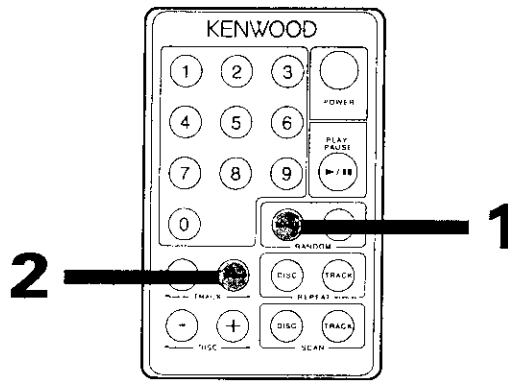

(Supplied with the KDC-C66FM)

1

Press the Magazine random button. The Magazine random play indicator will appear on the display and the track select will start. The track/disc numbers on the display will change continuously during track selection. When a track is selected, playback will begin automatically.

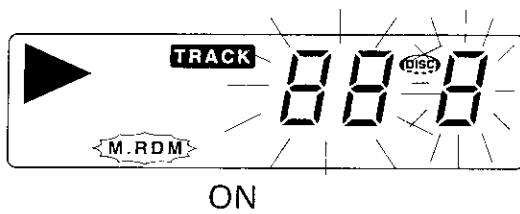

2

To select another track

Press the ►► button.

The player will randomly choose another track.

To cancel

Press the Magazine random button.

The Magazine random indicator disappears and Magazine random play is cancelled. Normal disc play starts.

NOTE

- When disc play stops, the Magazine random play function is cancelled.
- The Magazine random selection time changes according to the number of discs in the magazine.

Changing the transmission frequency

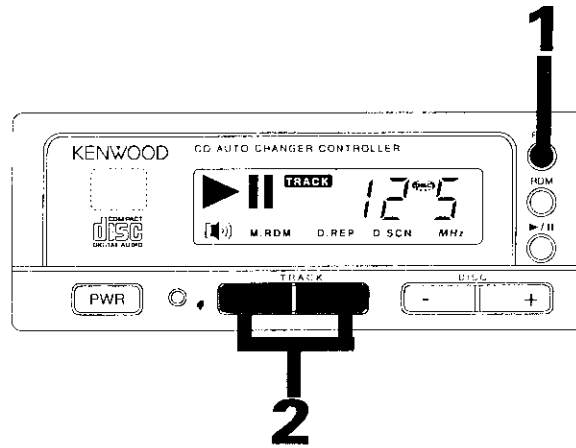

1 To set the frequency change mode

Hold down the REP button on the display unit for more than three seconds.

The FREQ indicator will light up and the currently set frequency will be displayed.



NOTE

- The initial value is 88.3MHz.
- If this function is on, the functions other than power on / off, reset, and modulation level / dynamic control, cannot be operated.
- This function is not available when the random play, repeat play, or scan play function is on. Before using this function, cancel the other functions. This function cannot be used while loading a disc (while the play indicator is blinking).

2 To change the frequency

Press the ◀◀ or ▶▶ button on the display unit.

The transmission frequency will change as follows:

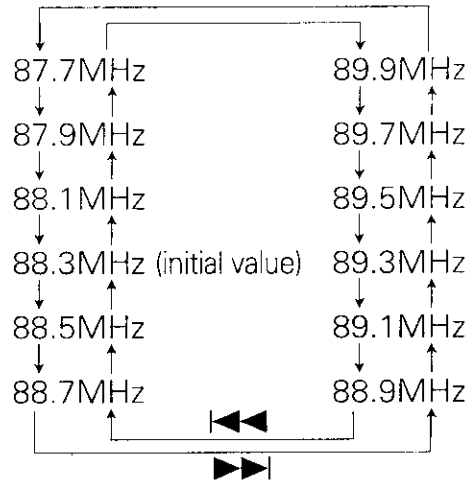

NOTE

Some car radios cannot receive a 87.7 MHz frequency.

To cancel

Hold down the REP button on the display unit for more than three seconds.

The FREQ indicator will go off and the frequency change will take effect. The frequency change mode is automatically cancelled if you do nothing for 15 seconds.

Modulation level / Dynamic control

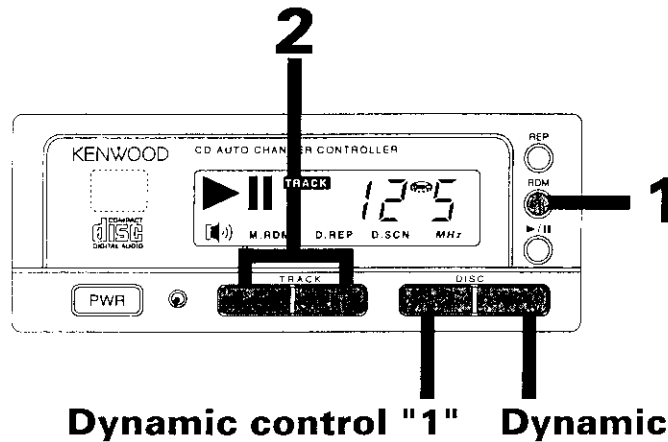

- 1** To set the control mode
Hold down the RDM button on the display unit for more than three seconds.
The LEVEL indicator will light up and the currently set modulation level will be displayed.

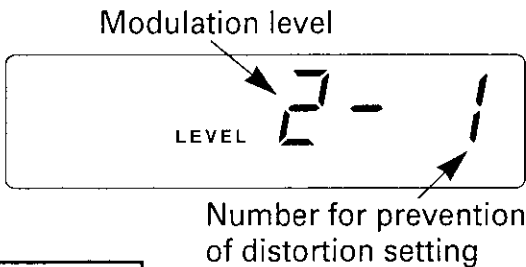

NOTE

- If this function is on, the functions other than power on / off, reset, and changing the transmission frequency, cannot be operated.
- This function is not available when the random play, repeat play, or scan play function is on. Before using this function, cancel the other functions. This function cannot be used while loading a disc (while the play indicator is blinking).

- 2** To change the modulation level
Press the ◀◀ or ▶▶ button on the display unit.

Each time the button is pressed, the modulation level changes in the range from 1 to 4. As the number increases, the modulation level increases. The initial setting is 2.

NOTE

Dynamic control

The unit comes with the prevention of distortion function to reduce sound distortion.

If the sound is distorted severely, press the + button on the display unit and then set the function to "2" (ON). If the prevention of distortion function is set to "2" (ON), the sound extension is reduced.

The initial setting is "1" (OFF).

CAUTION

If a disc with a high recording level is used, the sound may distort even if the prevention of distortion function is set to "2" (ON). In this case, reduce the modulation level.

To cancel

Hold down the RDM button on the display unit for more than three seconds.

The LEVEL indicator will go off and the modulation level change will take effect. The control mode is automatically cancelled if you do nothing for 15 seconds.

Installation procedure

1. Remove the ignition key and disconnect the negative (-) terminal of the battery to prevent short circuits.
2. Connect the input and output cables of the units.
3. Connect the ground cable, battery cable, and ignition cable of the wiring harness in the order listed.
4. Install the unit in the car.
5. Connect the negative (-) terminal of the battery.
6. Press the Reset button.

CAUTION

- If the fuse blows, check cables for shorts, then replace the fuse with one of the same rating.
- Check that no unconnected cables or connectors are touching the car body. Do not remove caps from unconnected cables or connectors to prevent short circuits.
- After installation, check that the brake lamps, wipers, and wipers work properly.
- Insulate unconnected ends of cords with vinyl tape or similar.
- Use only the supplied screws for installation. Use of any other screws may damage the unit.

Removing the transportation screws

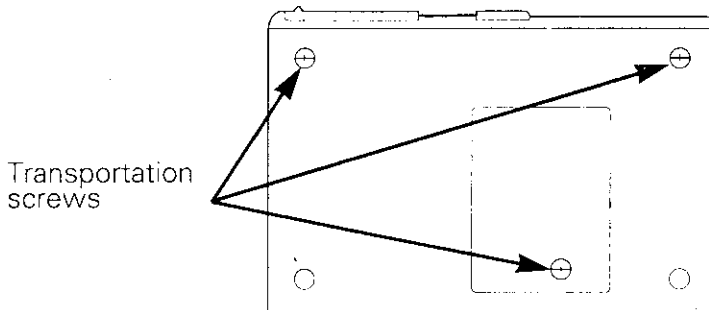

Remove all 3 transportation screws (minus) for protecting the internal mechanism before you start to install the unit.

NOTE

After removing the transport screw, retain it carefully and attach it again before transporting the unit again.

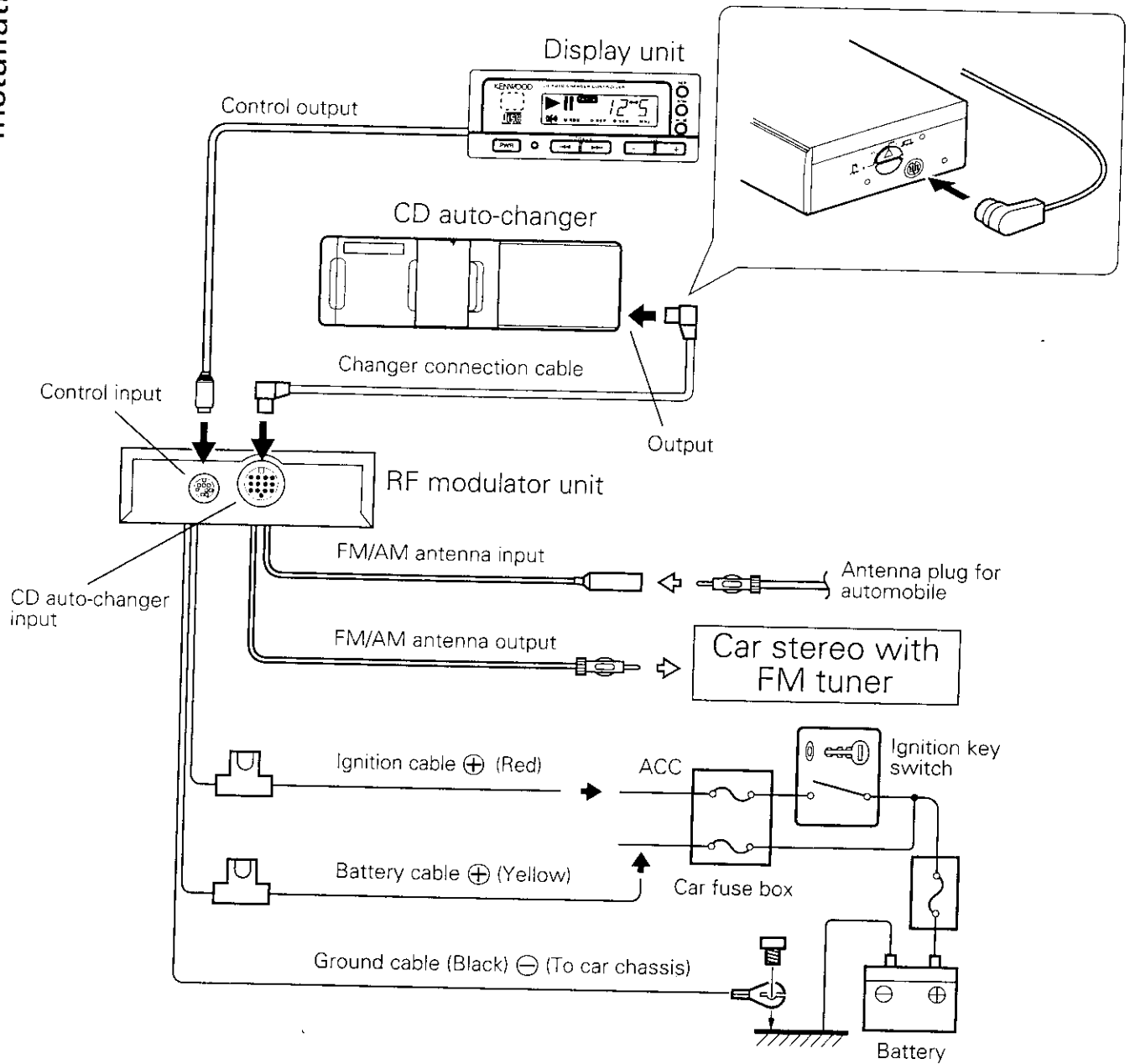

▲WARNING

To prevent fire when the ignition wire (Red) or battery wire (Yellow) is short-circuited by coming into contact with the vehicle chassis (ground), only connect the power supply after making the fuse box connections.

NOTE

Do not install an antenna of radio equipment or distribute the antenna cable near the changer output cable, for this could cause malfunction with this unit.

In case of hanging in the trunk

Cover the holes indicated by (E) with the dustproof seals (F). (Bottom and sides)
 Use the holes marked (●) to install the unit.

Bottom view

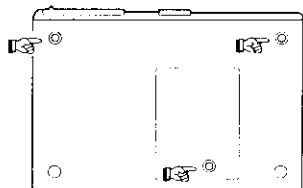

Side view

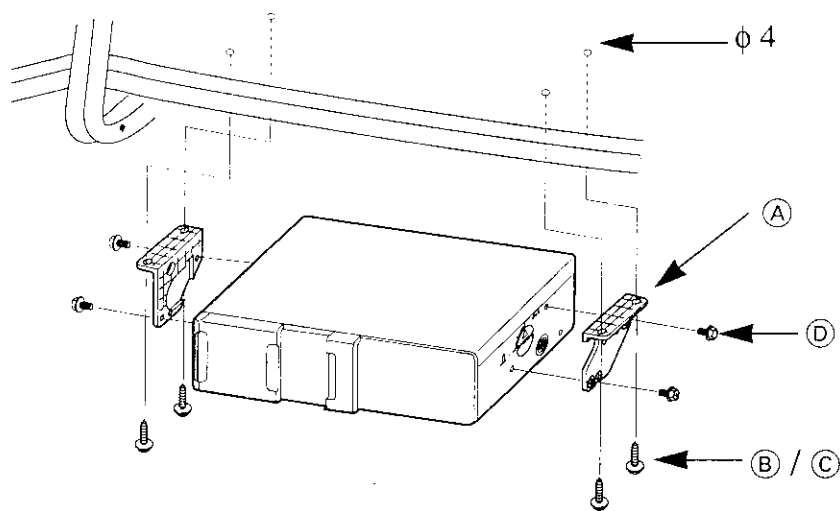
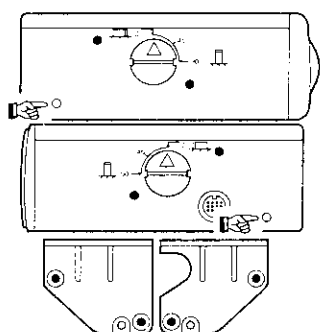

▲ CAUTION

Do not tighten the screw (D) too securely at the time of installation, but tighten it securely after having fixed the bracket (A).

Installation of Display unit

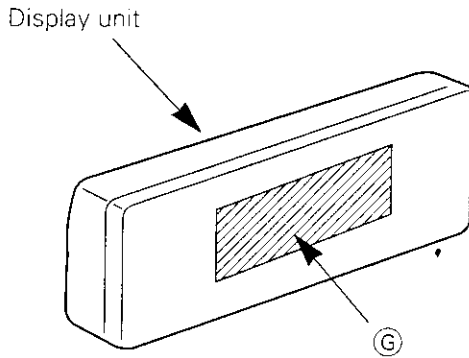

Attach one velcro to the slanted-line of the the display units as shown above, and attach the other velcro to the parts where you wish to attach the display units. Then, put velcros together and install the display units.

▲CAUTION

- Be sure not to place the unit on such place as where it is exposed to direct sunlight and temperature eventually rises. It results in the deformation of the case.
- Depending on the installing location, the display unit may not be able to receive the signals from the controller unit. Install them after confirming that the signals can be received.
- Install the unit in such a way that it does not disturb driving.

Installation of RF modulator unit

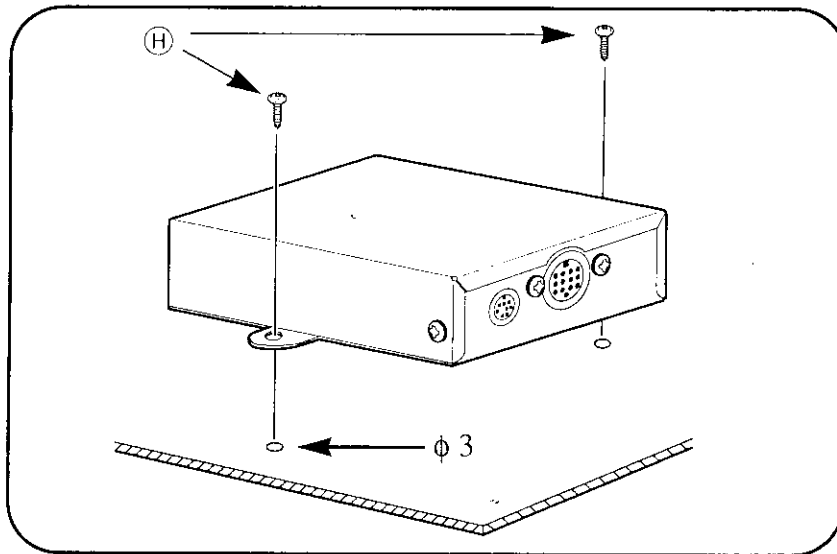

▲CAUTION

Take sufficient care so that the cables are not caught under the seat. If they are caught, they may break.

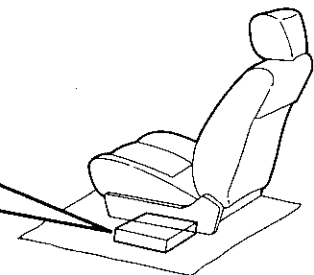

Troubleshooting guide

Often, what appears to be a malfunction is due to user error. Before calling for service please consult the following table.

Symptom	Cause	Remedy
The power is not turned on.	The wiring harness fuse blows.	Check cables for shorts, then replace the fuse with one of with the same rating (shown on the case).
No sound or sound is low.	The volume level is minimum.	Raise the volume level.
	The fader or balance is set to one side.	Adjust the fader and balance.
	The input/output cable or wiring harness is connected incorrectly.	Connect the input/output cable or wiring harness correctly. See "Connections" (Page 22).
The unit does not work properly when a button is pressed.	The microcomputer malfunctions.	Press the Reset button of the display unit.
Sound quality is poor. (Sound distortion)	The volume level is too high.	Use the appropriate volume level.
CD play does not start.	CD auto-changer input is not connected to the unit.	Connect the CD auto-changer input to the unit.
	Power button is not turned ON.	Turn the power button ON.
The specified disc is not played; a different disc is played instead.	The specified disc is very dirty.	Check and, if possible, clean the disc. See "Cleaning your discs" (Page 6).
	The disc is loaded upside down.	Eject the disc magazine and insert the disc correctly.
	Two discs are inserted in a slot.	Eject the disc magazine and insert the discs correctly.
	The number of the slot into which the disc is inserted is different from the number of the specified disc.	Eject the disc magazine and check the number of the specified disc.
	The disc is severely damaged.	Use another disc.
Sound skips due to vibration.	Something is touching the CD auto-changer.	Keep it away from the CD auto-changer.
	The disc is dirty or damaged.	If sound skips at the same part, the disc is faulty. Check and, if possible, clean the disc. See "Cleaning your discs" (Page 6).
	The unit is mounted at a slant.	Mount the unit so that is level.
	Changer unit is mounted in an unstable place.	Mount the unit in a stable place.
	The angle adjustment switches are set improperly.	Set the angle adjustment switches to the correct positions.
Nothing appears on the display.	The control output of the display unit is not connected properly.	Connect the control output properly.
Sound distortion.	A disc with a high recording level is used.	See Page 20. Change the modulation level / dynamic control setting.

Symptom	Cause	Remedy
Sound quality is poor.	The recording of the disc is poor.	Try playing another disc. If the sound is good, the fault was with the original disc.
	The disc is dirty or damaged.	Check and, if possible, clean the disc. See "Cleaning your discs (Page 6)".
No sound is heard even though the information concerning the CD auto-changer is displayed.	Volume is set to minimum level.	Raise the volume level.
	The microcomputer does not function correctly.	Press the Reset button of the display unit.
	The system is not connected properly.	Connect the system properly. See "Connections" (Page 22).
The specified track is not played.	The player is set to RANDOM PLAY/MAGAZINE RANDOM PLAY.	Turn off RANDOM PLAY/MAGAZINE RANDOM PLAY.

In some cases, you may see one of the following error messages on your unit's display.

- 01 E:** No disc magazine has been loaded in the changer. The disc magazine is not completely loaded.
⇒ Load the disc magazine properly.
- 02 E:** No disc has been loaded in the disc magazine..
⇒ Load a disc into the disc magazine.
- 04 E:** No disc has been loaded in the disc magazine.
⇒ Load a disc into the disc magazine
The CD is quite dirty. The CD is upside-down. The CD is scratched a lot.
⇒ Clean the CD and load it correctly.
- 77 E:** The unit malfunctions due to a defective CD mechanism.
- 99 E:** Press the Reset button. If the "77 E", "99 E" message does not disappear, contact your Kenwood dealer.
- 0d E:** When the temperature exceeds 60°C, a protection circuit will stop all operations. This message will then be displayed.
⇒ Let the place where the changer is located cool down. As soon as it has cooled, the changer starts playing.

Specifications subject to change without notice.

Disc Section

Laser Diode	GaAlAs ($\lambda=780$ nm)
Digital Filter (D/A)	8 Times Over Sampling
D/A Converter.....	1 bit
Spindle speed.....	500 ~ 200 rpm (CLV)
Wow & Flutter.....	Below Measurable Limit
Modulating Frequency (200KHz STEP).....	87.7, 87.9, 88.1, 88.3, 88.5, 88.7, 88.9, 89.1, 89.3, 89.5, 89.7, 89.9 MHz

General

Operating Voltage.....	14.4 V (11 ~ 16 V)
Current consumption.....	1.4 A
Operating Temperature.....	-10 ~ 50 °C
Size (W × H × D)	
CD changer.....	250 × 64 × 173 mm (9-13/16 × 2-1/2 × 6-13/16 in.)
Controller(Supplied with the KDC-C66FM)	54 × 85 × 5 mm (2-1/8 × 3-3/8 × 3/16 in.)
Display unit.....	105 × 40 × 18 mm (4-1/8 × 1-9/16 × 11/16 in.)
RF modulator unit.....	150 × 30 × 80 mm (5-7/8 × 1-3/16 × 3-1/8 in.)
Weight	
CD changer.....	1.8 kg (4.0 lbs)
Controller(Supplied with the KDC-C66FM)	0.028 kg (0.06 lbs)
Display unit.....	0.125 kg (0.28 lbs)
RF modulator unit.....	0.456 kg (1.0 lbs)